

3.124
PESO TCO: 0.223
PERIMETRO: 0.10

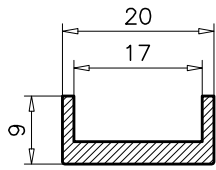

3.283
PESO TCO: 0.211
PERIMETRO: 0.10

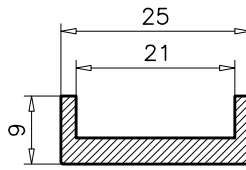

3.297
PESO TCO: 0.297
PERIMETRO: 0.10

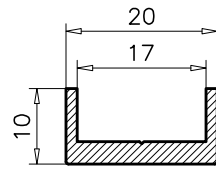

6.285
PESO TCO: 0.219
PERIMETRO: 0.10

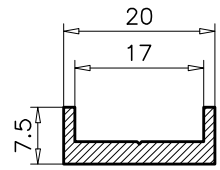

7.724
PESO TCO: 0.197
PERIMETRO: 0.10

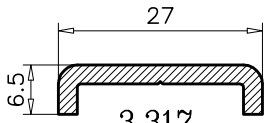

3.317
PESO TCO: 0.230
PERIMETRO: 0.10

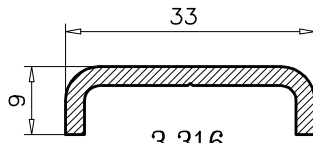

3.316
PESO TCO: 0.292
PERIMETRO: 0.10

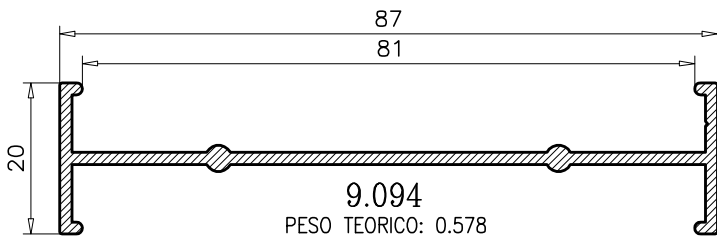

9.094
PESO TEORICO: 0.578
PERIMETRO: 0.26



4.033
PESO TEORICO: 0.238
PERIMETRO: 0.15

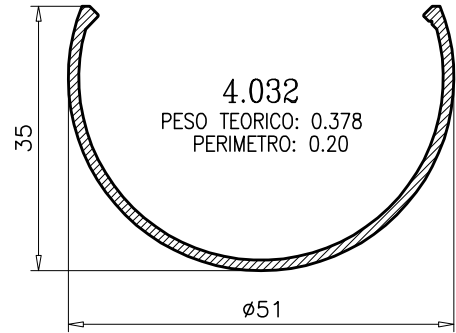

4.032
PESO TEORICO: 0.378
PERIMETRO: 0.20

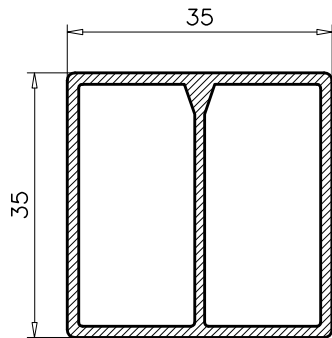

6.303
PESO TEORICO: 0.670
PERIMETRO: 0.32

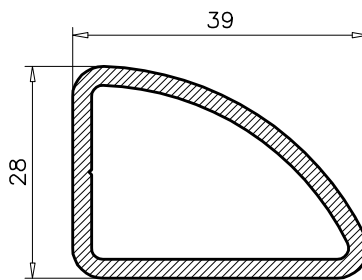

6.617
PESO TEORICO: 0.721
PERIMETRO: 0.21

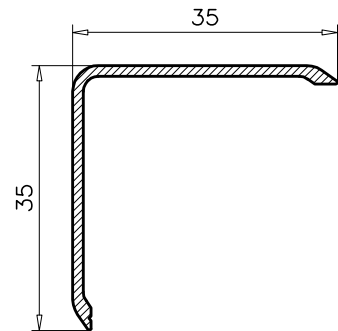

7.281
PESO TEORICO: 0.257
PERIMETRO: 0.14

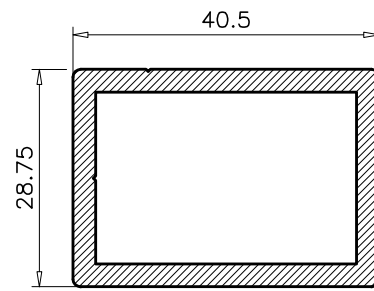
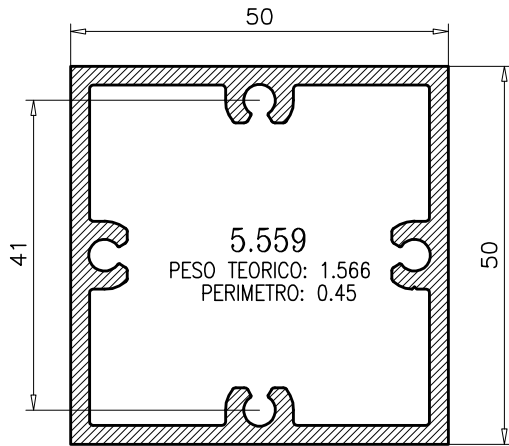

9.362
PESO TEORICO: 1.021
PERIMETRO: 0.25

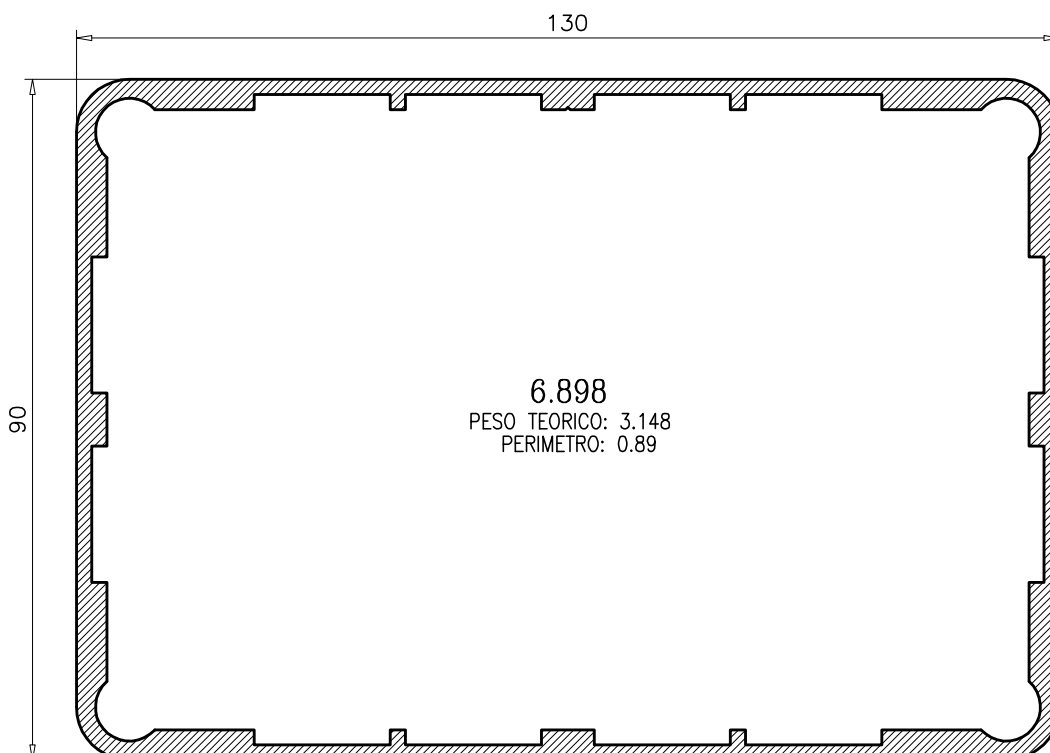
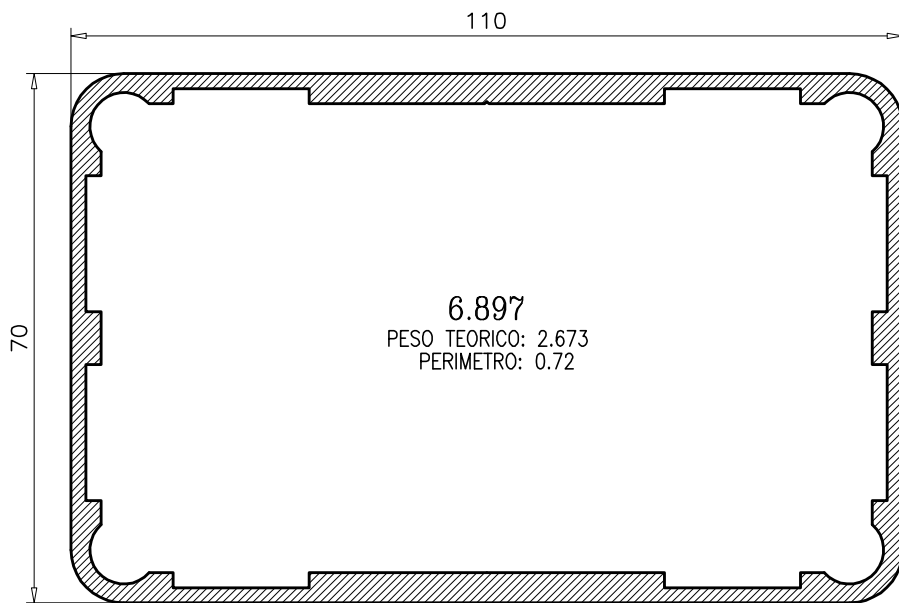

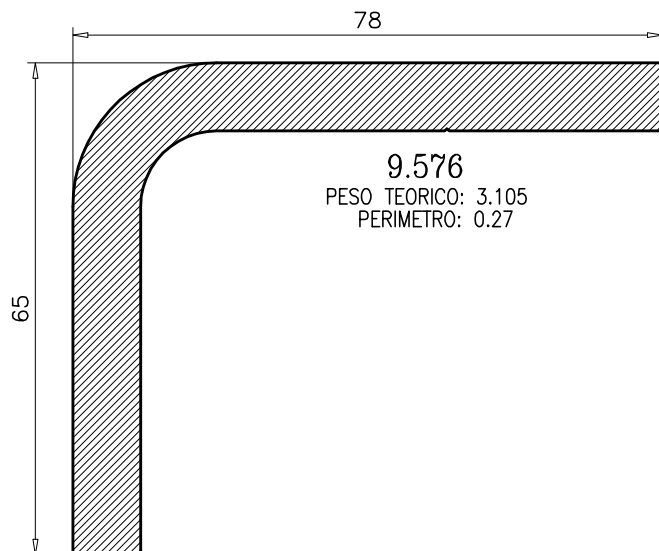
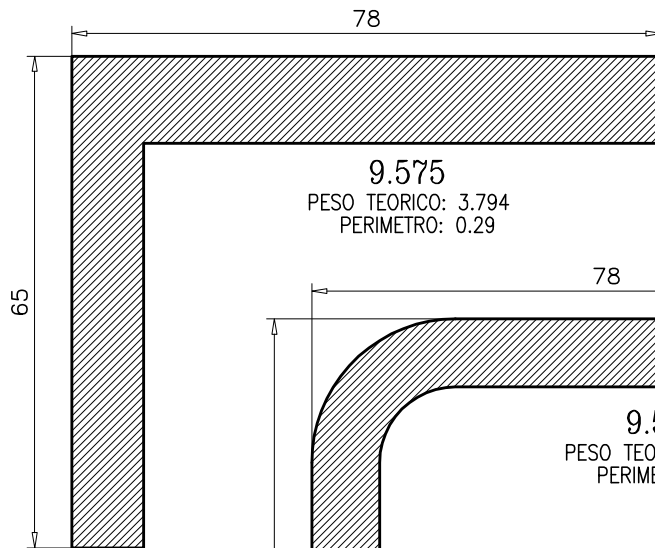
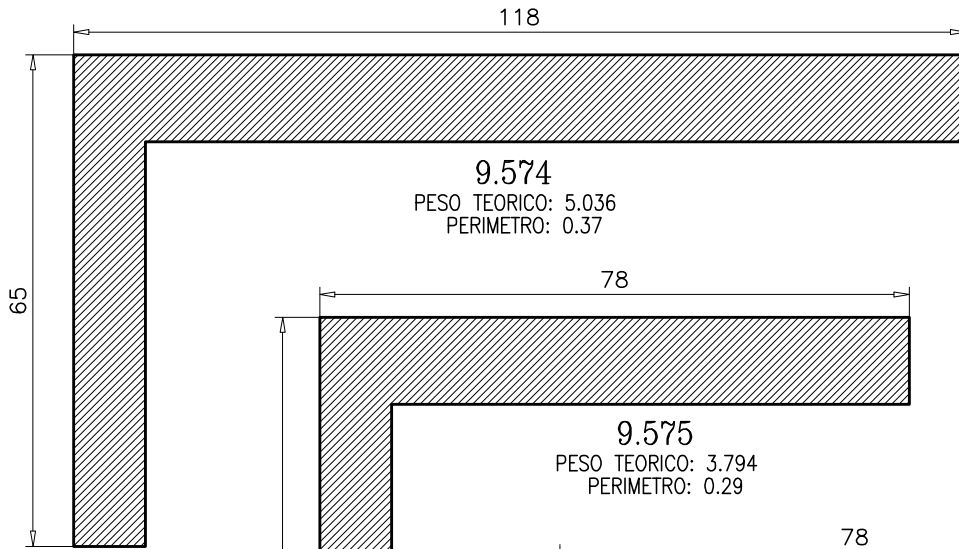
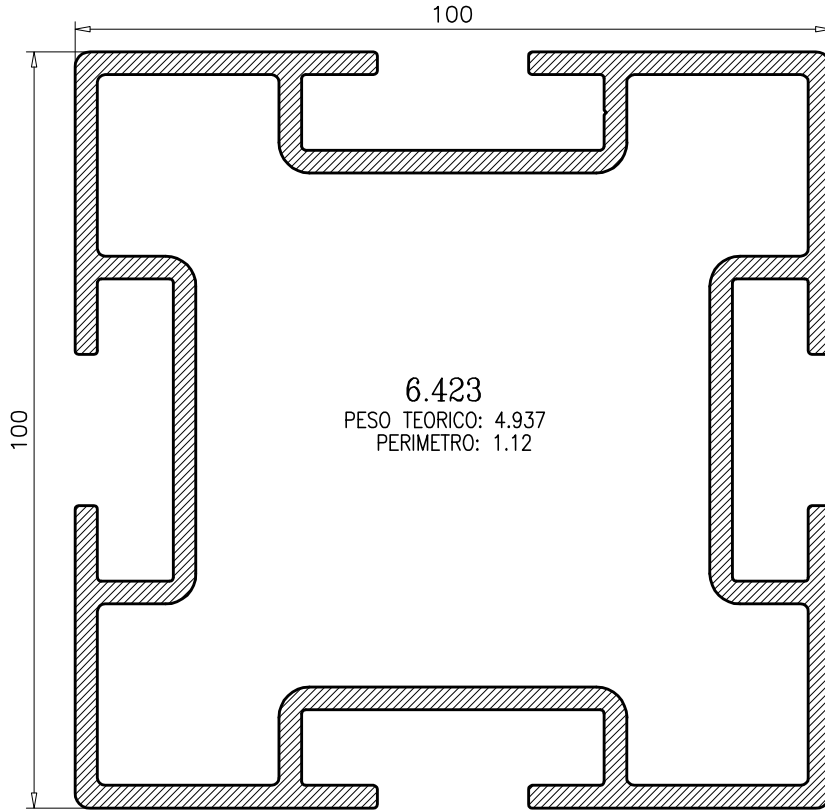

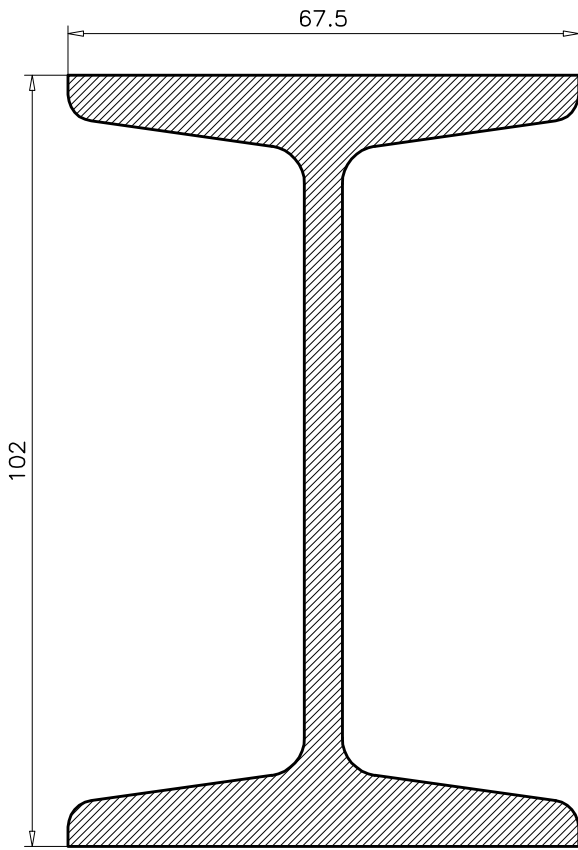
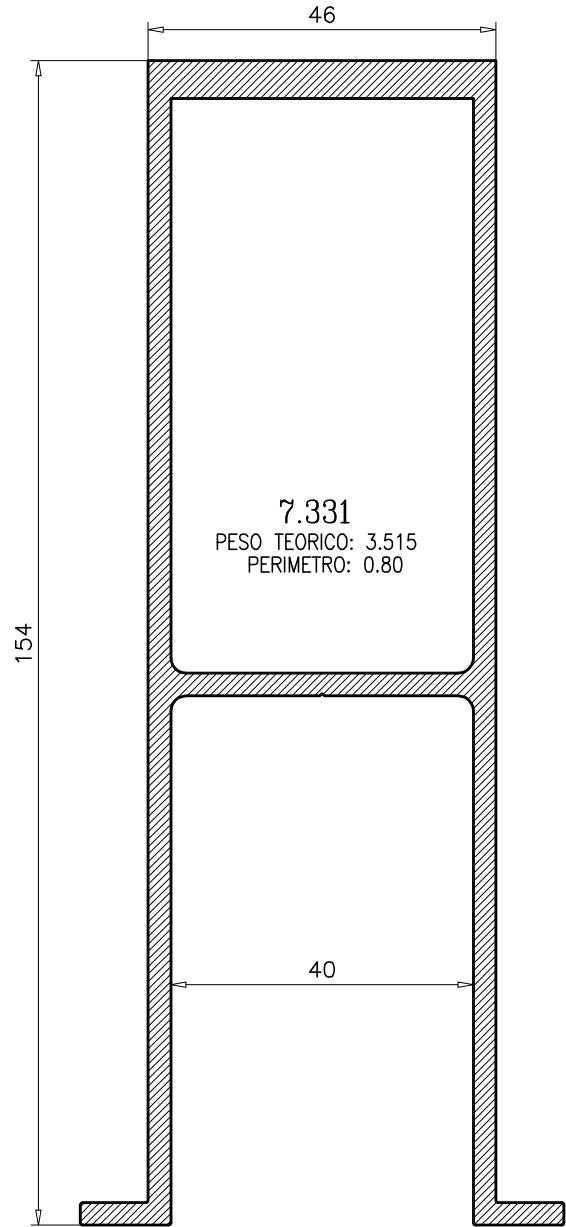
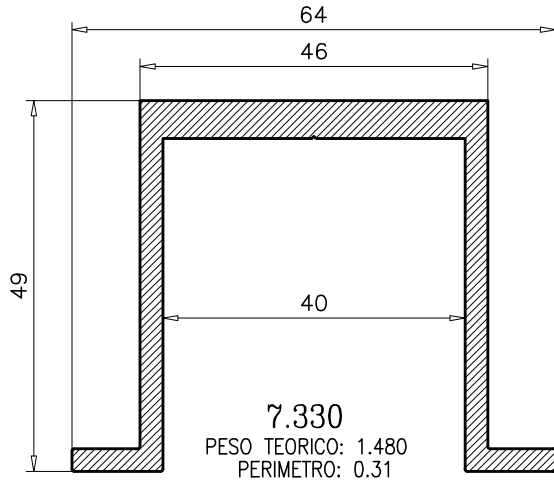

7.397
PESO TEORICO: 4.039
PERIMETRO: 0.44

