

4.143
PESO TEORICO: 0.122
PERIMETRO: 0.10

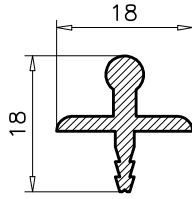

4.024
PESO TEORICO: 0.216
PERIMETRO: 0.10

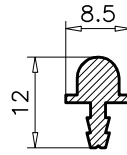

4.938
PESO TEORICO: 0.127
PERIMETRO: 0.10

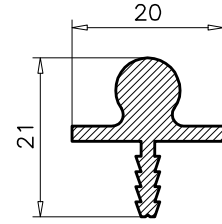

4.957
PESO TEORICO: 0.343
PERIMETRO: 0.10

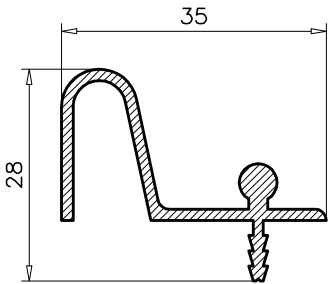

4.025
PESO TEORICO: 0.362
PERIMETRO: 0.17

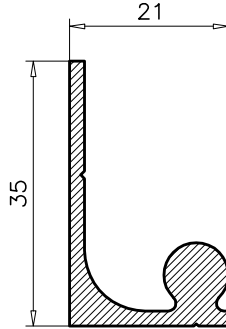

5.162
PESO TEORICO: 0.122
PERIMETRO: 0.10

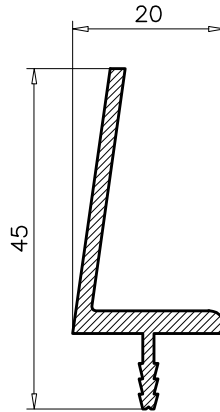

4.667
PESO TEORICO: 0.381
PERIMETRO: 0.13

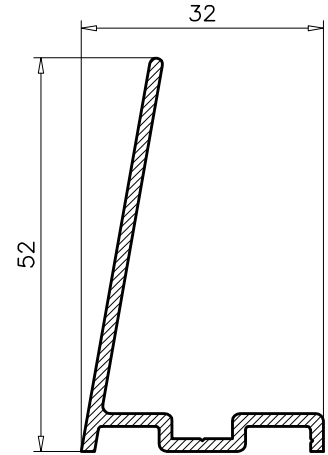

6.178
PESO TEORICO: 0.421
PERIMETRO: 0.19

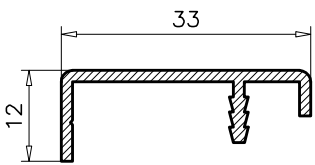

5.164
PESO TEORICO: 0.232
PERIMETRO: 0.12

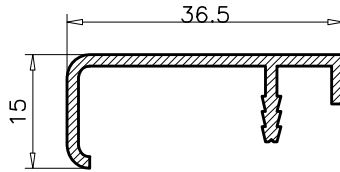

4.439
PESO TEORICO: 0.270
PERIMETRO: 0.14

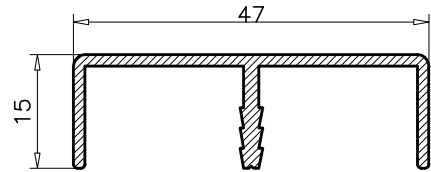

5.142
PESO TEORICO: 0.381
PERIMETRO: 0.18

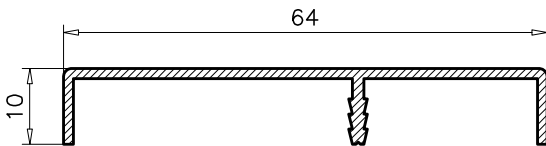

6.873
PESO TEORICO: 0.327
PERIMETRO: 0.18

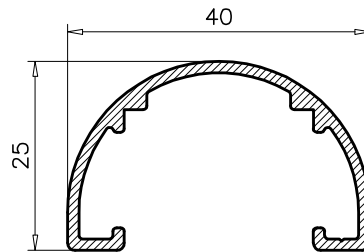

5.230
PESO TEORICO: 0.383
PERIMETRO: 0.18

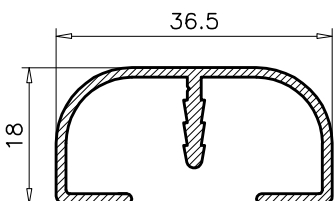

5.468
PESO TEORICO: 0.346
PERIMETRO: 0.19

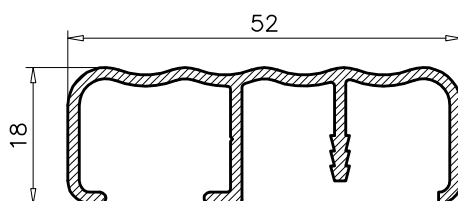

5.758
PESO TEORICO: 0.486
PERIMETRO: 0.24

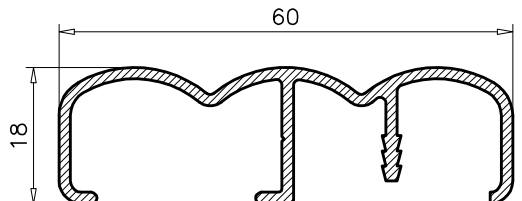

5.934
PESO TEORICO: 0.518
PERIMETRO: 0.25

