

5.355
PESO TEORICO: 0.435
PERIMETRO: 0.21

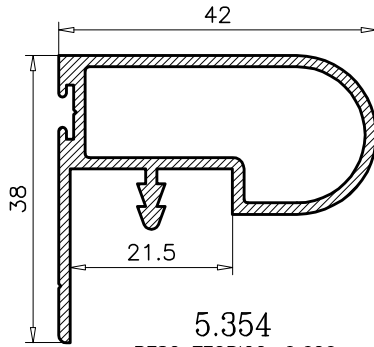

5.354
PESO TEORICO: 0.626
PERIMETRO: 0.29

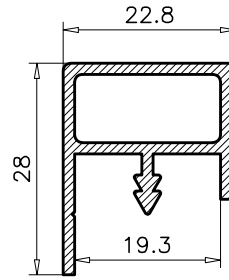

7.984
PESO TEORICO: 0.410
PERIMETRO: 0.19

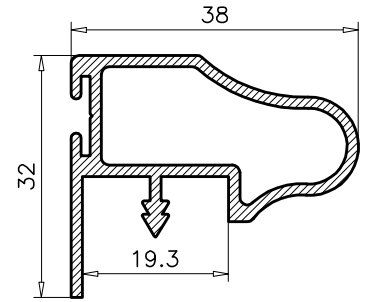

8.421
PESO TEORICO: 0.562
PERIMETRO: 0.26

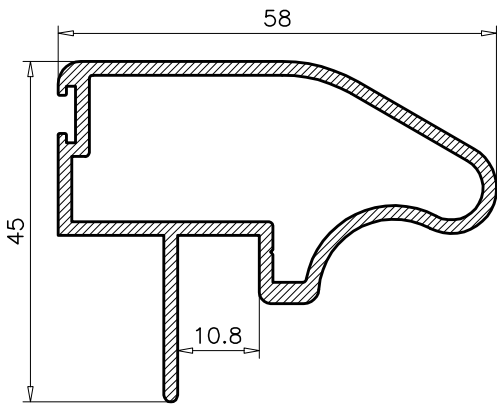

8.423
PESO TEORICO: 0.905
PERIMETRO: 0.36

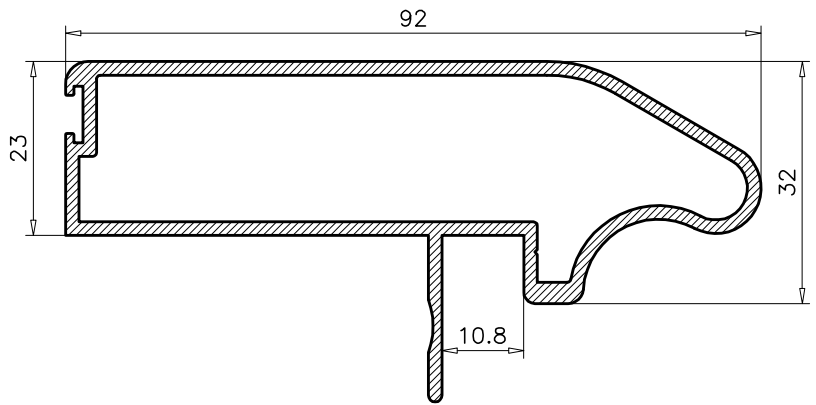

8.424
PESO TEORICO: 1.226
PERIMETRO: 0.50

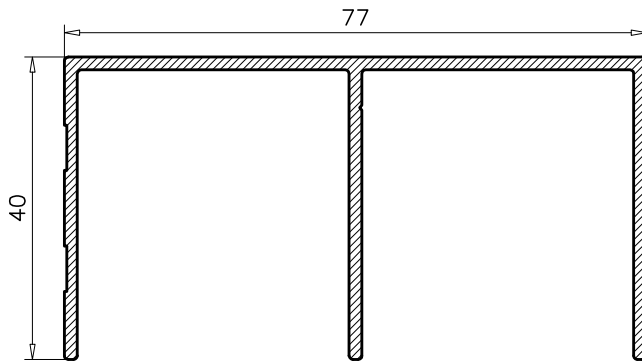

5.457
PESO TEORICO: 0.864
PERIMETRO: 0.39

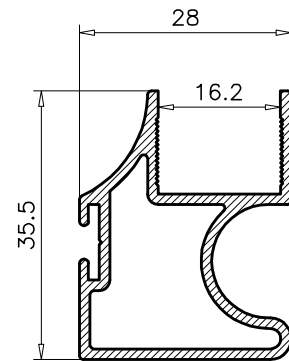

5.459
PESO TEORICO: 0.532
PERIMETRO: 0.28

5.458
PESO TCO: 0.329
PERIMETRO: 0.17

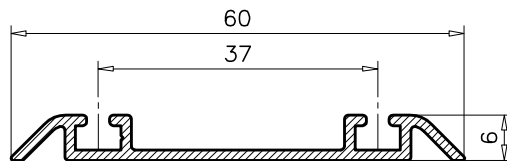

9.837
PESO TCO: 0.225
PERIMETRO: 0.12

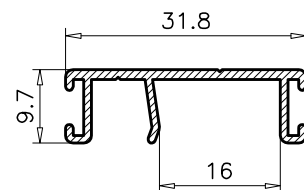
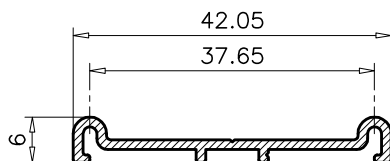

9.838
PESO TEORICO: 0.203
PERIMETRO: 0.13

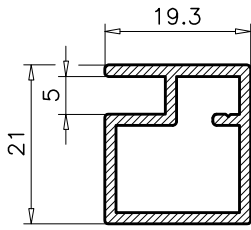

6.520
 PESO TCO: 0.348
 PERIMETRO: 0.17

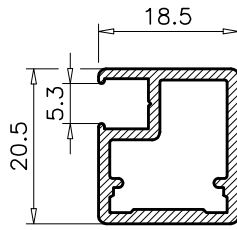

8.420
 PESO TCO: 0.340
 PERIMETRO: 0.16

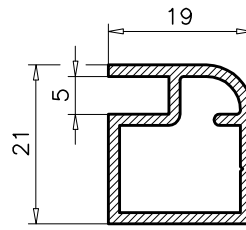

4.095
 PESO TCO: 0.335
 PERIMETRO: 0.17

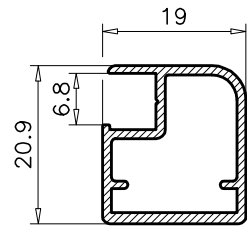

10.576
 PESO TCO: 0.278
 PERIMETRO: 0.17

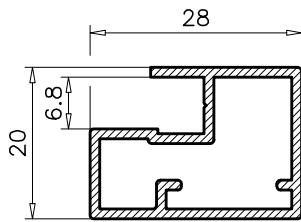

10.879
 PESO TCO: 0.375
 PERIMETRO: 0.21

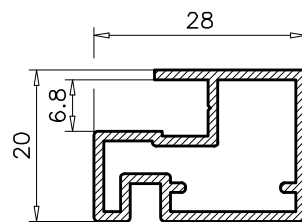

10.880
 PESO TCO: 0.397
 PERIMETRO: 0.22

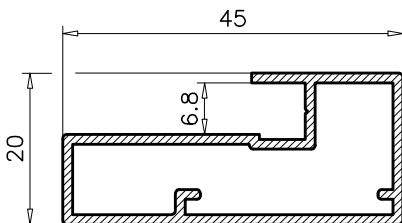

10.863
 PESO TCO: 0.491
 PERIMETRO: 0.28

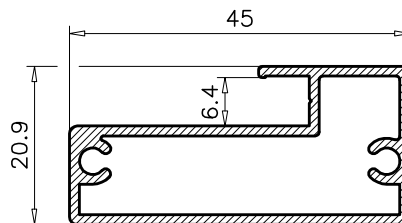

8.312
 PESO TCO: 0.535
 PERIMETRO: 0.30

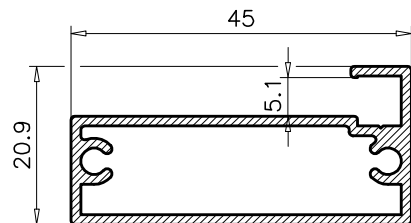

8.264
 PESO TCO: 0.518
 PERIMETRO: 0.28

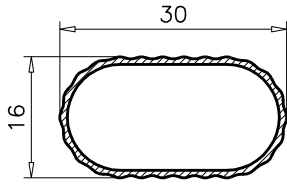

2.332
PESO TCO: 0.172
PERIMETRO: 0.15

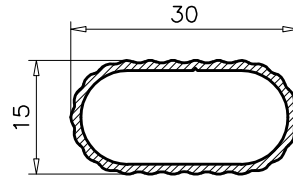

9.261
PESO TCO: 0.227
PERIMETRO: 0.15

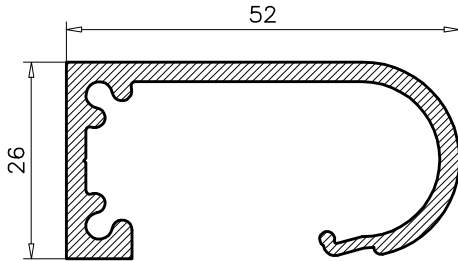

3.647
PESO TCO: 0.832
PERIMETRO: 0.24

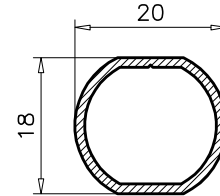

3.753
PESO TCO: 0.205
PERIMETRO: 0.12

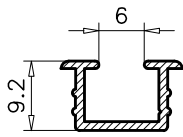

6.280
PESO TCO: 0.113
PERIMETRO: 0.10

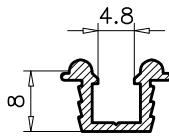

9.552
PESO TCO: 0.124
PERIMETRO: 0.10

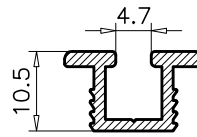

9.553
PESO TCO: 0.176
PERIMETRO: 0.10

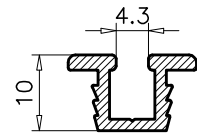

10.584
PESO TCO: 0.167
PERIMETRO: 0.10

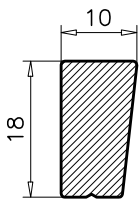

9.456
PESO TCO: 0.437
PERIMETRO: 0.10

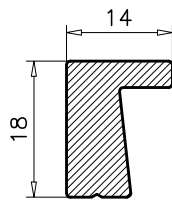

9.457
PESO TCO: 0.435
PERIMETRO: 0.10

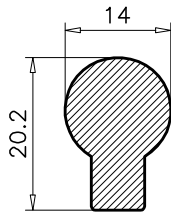

9.617
PESO TCO: 0.537
PERIMETRO: 0.10

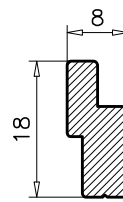

9.945
PESO TCO: 0.281
PERIMETRO: 0.10

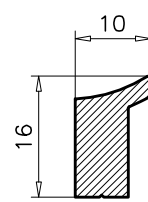

10.219
PESO TCO: 0.278
PERIMETRO: 0.10

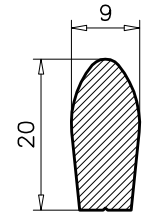

10.220
PESO TCO: 0.402
PERIMETRO: 0.10

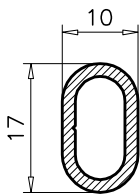

9.654
PESO TCO: 0.184
PERIMETRO: 0.10

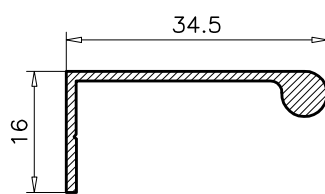

9.896
PESO TCO: 0.235
PERIMETRO: 0.11

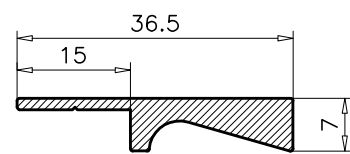

9.453
PESO TCO: 0.351
PERIMETRO: 0.10

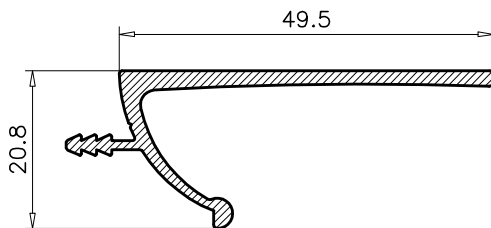

9.405
PESO TCO: 0.427
PERIMETRO: 0.17

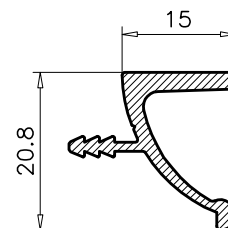

9.406
PESO TCO: 0.257
PERIMETRO: 0.10

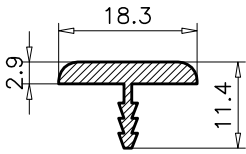

2.823
 PESO TEORICO: 0.173
 PERIMETRO: 0.10

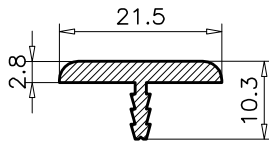

3.925
 PESO TEORICO: 0.194
 PERIMETRO: 0.10

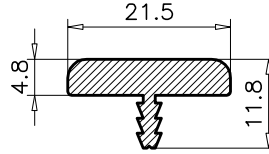

5.402
 PESO TEORICO: 0.313
 PERIMETRO: 0.10

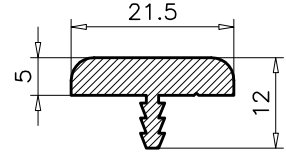

3.021
 PESO TEORICO: 0.324
 PERIMETRO: 0.10

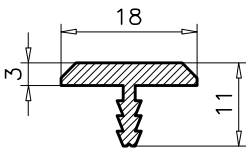

4.326
 PESO TEORICO: 0.184
 PERIMETRO: 0.10

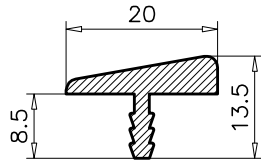

7.679
 PESO TEORICO: 0.243
 PERIMETRO: 0.10

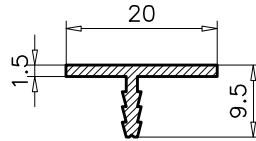

6.544
 PESO TEORICO: 0.121
 PERIMETRO: 0.10

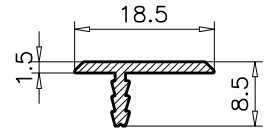

8.260
 PESO TEORICO: 0.105
 PERIMETRO: 0.10

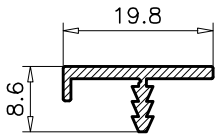

4.751
 PESO TEORICO: 0.127
 PERIMETRO: 0.10

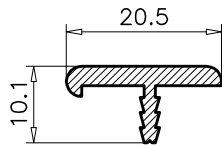

3.926
 PESO TEORICO: 0.184
 PERIMETRO: 0.10

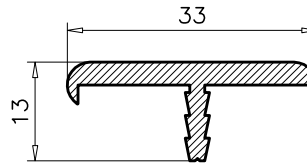

4.334
 PESO TEORICO: 0.332
 PERIMETRO: 0.10

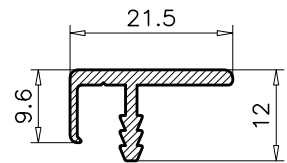

7.696
 PESO TEORICO: 0.189
 PERIMETRO: 0.10

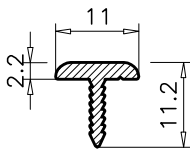

9.432
 PESO TEORICO: 0.115
 PERIMETRO: 0.10

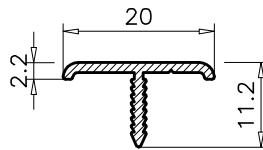

9.433
 PESO TEORICO: 0.126
 PERIMETRO: 0.10

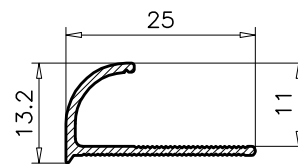

9.112
 PESO TEORICO: 0.140
 PERIMETRO: 0.10

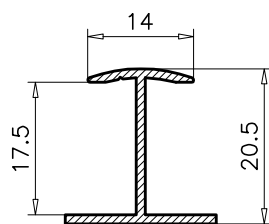

5.561
 PESO TEORICO: 0.165
 PERIMETRO: 0.11

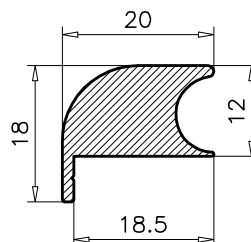

9.190
 PESO TEORICO: 0.559
 PERIMETRO: 0.10

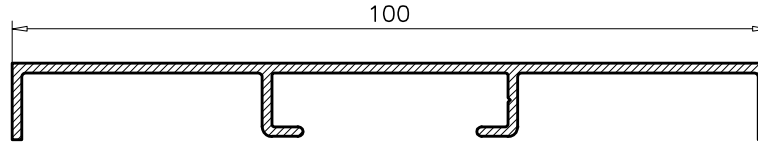

3.105
 PESO TEORICO: 0.500
 PERIMETRO: 0.29

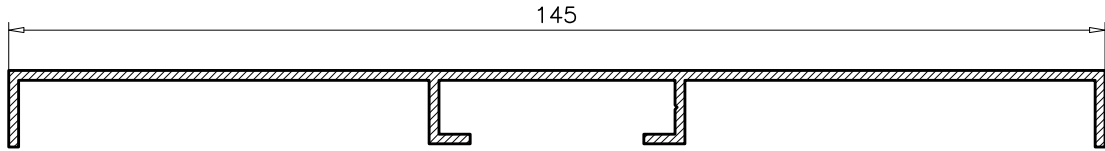

2.447
 PESO TEORICO: 0.659
 PERIMETRO: 0.38

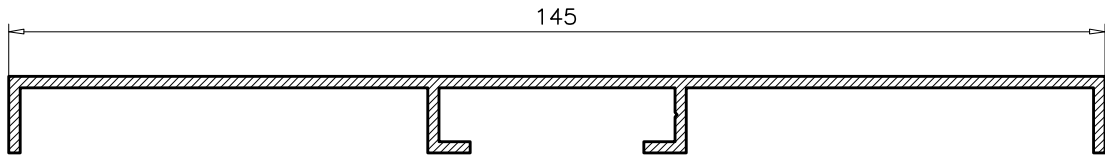

1.824
 PESO TEORICO: 0.760
 PERIMETRO: 0.38

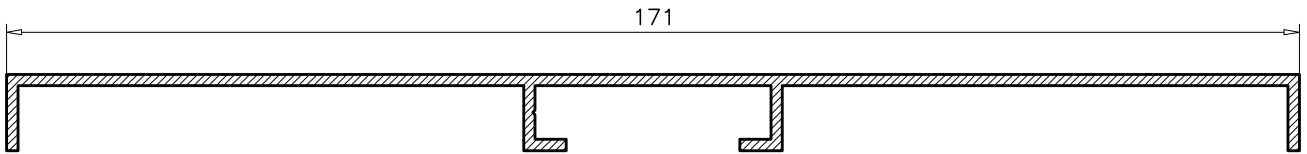

4.555
 PESO TEORICO: 0.864
 PERIMETRO: 0.43

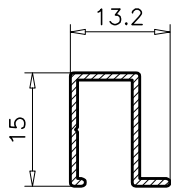

6.289
 PESO TEORICO: 0.113
 PERIMETRO: 0.10

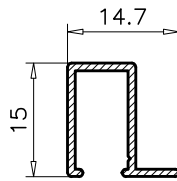

10.114
 PESO TEORICO: 0.119
 PERIMETRO: 0.10

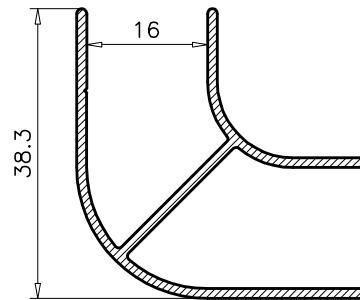

2.895
 PESO TEORICO: 0.437
 PERIMETRO: 0.25

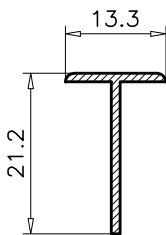

3.474
 PESO TEORICO: 0.103
 PERIMETRO: 0.10

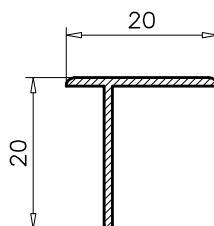

1.101
 PESO TEORICO: 0.113
 PERIMETRO: 0.10

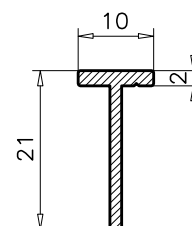

8.800
 PESO TEORICO: 0.130
 PERIMETRO: 0.10

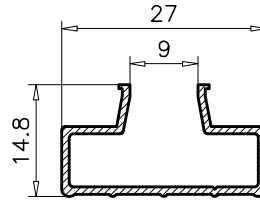
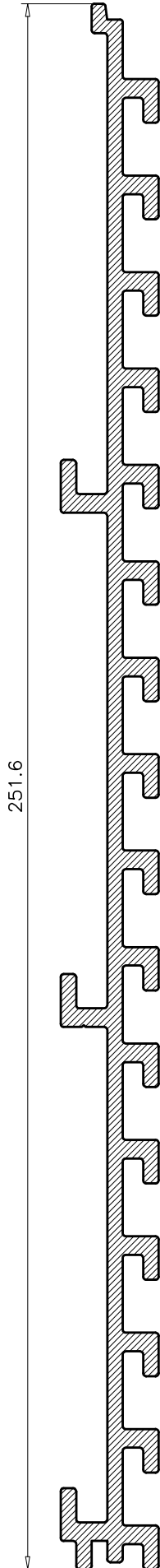

6.537
PESO TEORICO: 0.218
PERIMETRO: 0.14

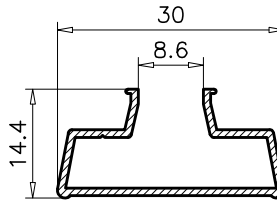

8.223
PESO TEORICO: 0.194
PERIMETRO: 0.15

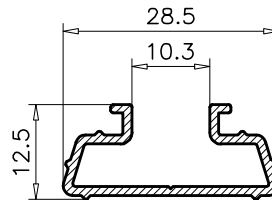

9.593
PESO TEORICO: 0.213
PERIMETRO: 0.13

8.390
PESO TEORICO: 3.213
PERIMETRO: 0.89

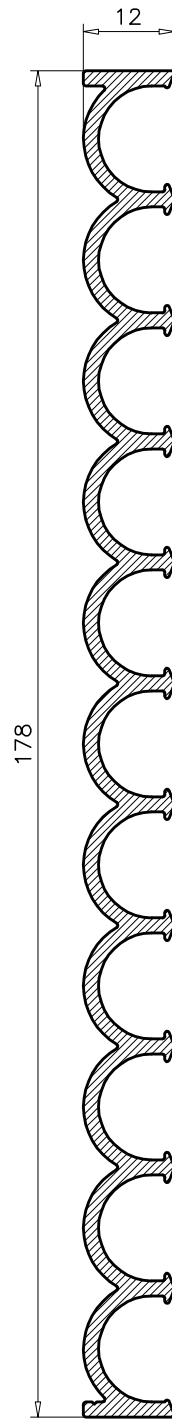

6.122
PESO TEORICO: 1.620
PERIMETRO: 0.59

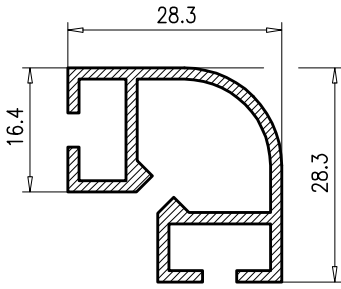

2.950
 PESO TEORICO: 0.478
 PERIMETRO: 0.23
 ESPESOR: 1.5

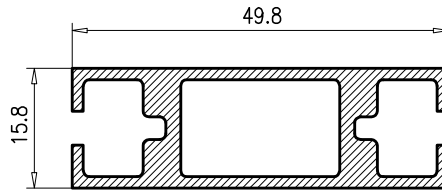

2.952
 PESO TEORICO: 0.772
 PERIMETRO: 0.28
 ESPESOR: 1.5

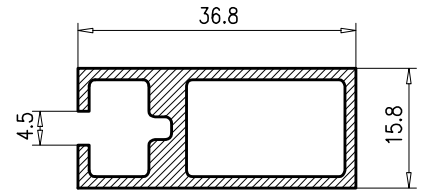

2.951
 PESO TEORICO: 0.535
 PERIMETRO: 0.21
 ESPESOR: 1.5

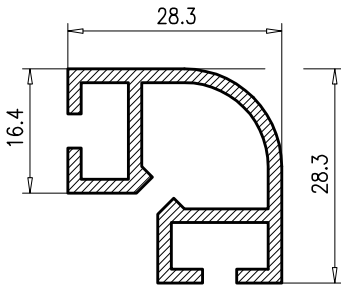

1.396
 PESO TEORICO: 0.551
 PERIMETRO: 0.23
 ESPESOR: 1.8

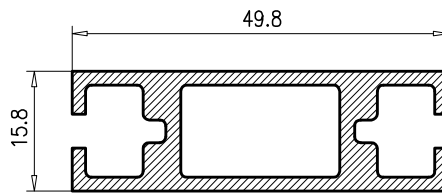

1.401
 PESO TEORICO: 0.845
 PERIMETRO: 0.27
 ESPESOR: 1.8

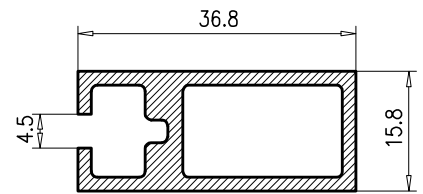

1.402
 PESO TEORICO: 0.597
 PERIMETRO: 0.21
 ESPESOR: 1.8

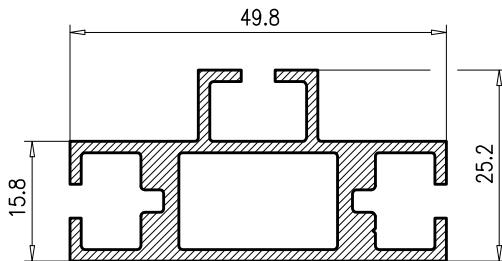

3.623
 PESO TEORICO: 0.880
 PERIMETRO: 0.33

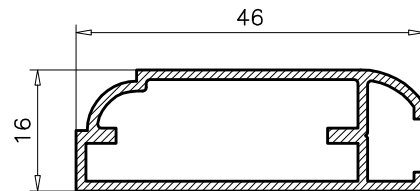

6.490
 PESO TEORICO: 0.459
 PERIMETRO: 0.25

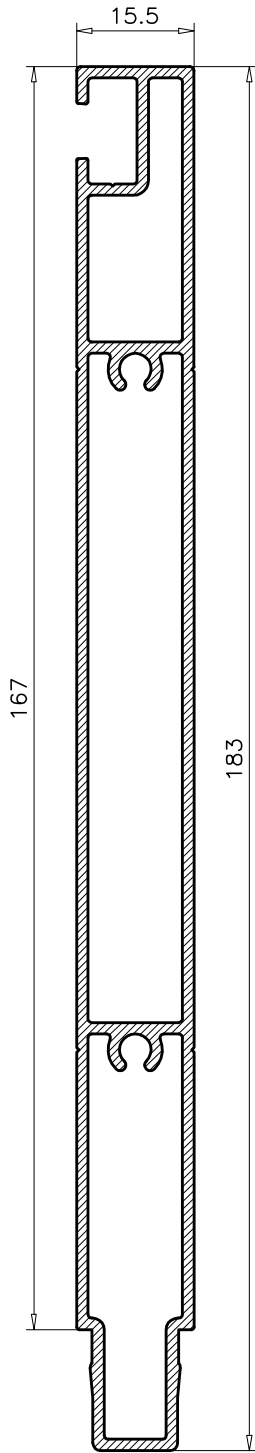

7.905
PESO TEORICO: 1.836
PERIMETRO: 0.88

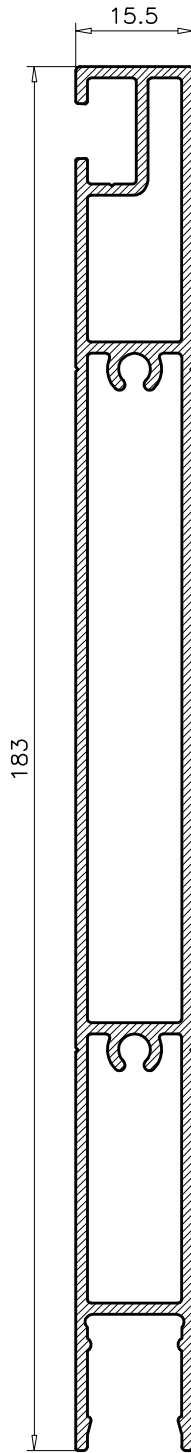

7.906
PESO TEORICO: 1.836
PERIMETRO: 0.89

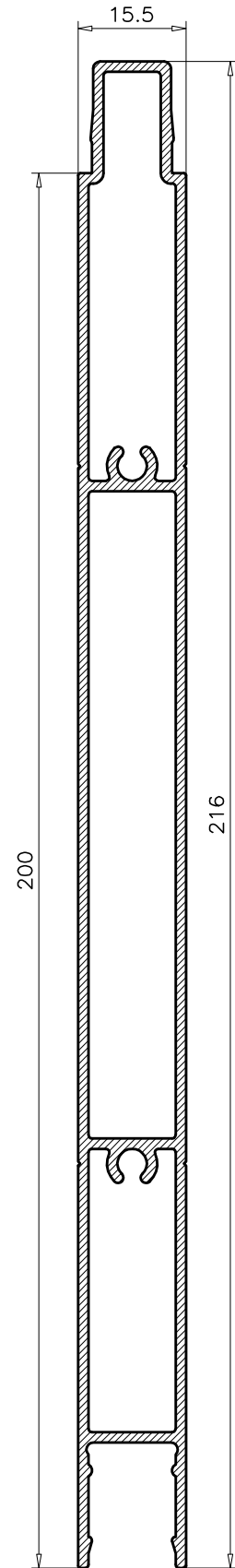

7.907
PESO TEORICO: 2.049
PERIMETRO: 0.99

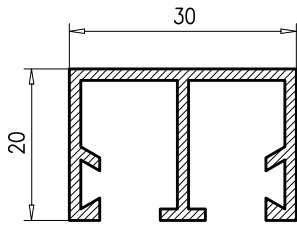

2.248
 PESO TEORICO: 0.419
 PERIMETRO: 0.21

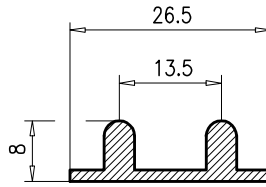

2.249
 PESO TEORICO: 0.239
 PERIMETRO: 0.1

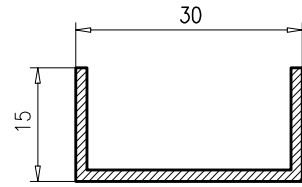

2.250
 PESO TEORICO: 0.231
 PERIMETRO: 0.12

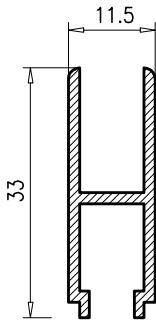

2.251
 PESO TEORICO: 0.308
 PERIMETRO: 0.16

**ESQUEMA
 DE MONTAJE**

